

Memorandum of common provisions

Section 91A Transfer of Land Act 1958

**PLAN / DOCUMENT AS REQUIRED UNDER CONDITION OF PERMIT
PLANNING AND ENVIRONMENT ACT 1987
WYNDHAM PLANNING SCHEME**

Privacy Collection Statement

The information in this form is collected under statutory authority and is used for the purpose of maintaining publicly searchable registers and indexes.

Permit No: WYP10168/17.08
Condition No: 5
Sheet: 1 of 53
Approved by: Benny Singh
WYNDHAM CITY COUNCIL
Date: 14 March 2019

Lodged by	
Name:	
Phone:	
Address:	
Reference:	
Customer code:	

This memorandum contains provisions which are intended for inclusion in instruments and plans to be subsequently lodged for registration.

Provisions:

RECITALS

- A. This MCP has been prepared by Development Victoria in order to regulate the siting, form and design of the residential development in accordance with the requirement to ensure a high level of amenity for owners and residents of the allotments within the Plan of Subdivision.
- B. The provisions of this MCP are incorporated into a restriction created by the Plan of Subdivision being PS 820862U known as Stage 24 of the Riverwalk Estate, Werribee.
- C. This MCP provides details of approved building envelopes.
- D. This MCP provides information necessary to interpret the approved building envelopes.
- E. The MCP imposes restrictions on the design and siting of buildings which in some cases may be different to those in the Building Regulations. In some cases the restrictions in this MCP may be stricter than the Building Regulations, and in other cases, the siting restrictions may be contrary to the Building Regulations.
- F. Where the siting restrictions in this MCP are contrary to regulations 409, 411, 414, 415, 416 and 420 of the Building Regulations, no consent and report of the relevant council is required, as this MCP has been prepared with regard to regulation 406 of the Building Regulations.
- G. Some matters addressed in this MCP are not covered by the Building Regulations.

1. DEFINITIONS

- 1.1 **'Approved Building Envelope'** means the building envelope shown for a particular allotment in the attached Building Envelopes Plan and has the same meaning as in regulation 402 of the Building Regulations.
- 1.2 **'Building'** has the same meaning as in the Building Act.
- 1.3 **'Building Act'** means the Building Act 1993 as amended from time to time.
- 1.4 **'Building Envelopes Plan'** means the plan that forms part of this MCP and which shows the Approved Building Envelopes and other related matters for the lots within the Plan of Subdivision.

35271702A

V3

1. The provisions are to be numbered consecutively from number 1.
2. Further pages may be added but each page should be consecutively numbered.
3. To be used for the inclusion of provisions in instruments and plans.

91ATLA

Page 1 of 6

THE BACK OF THIS FORM MUST NOT BE USED

Land Use Victoria contact details: see www.delwp.vic.gov.au/property>Contact us

Memorandum of common provisions
Section 91A Transfer of Land Act 1958

PLAN / DOCUMENT AS REQUIRED UNDER CONDITION OF PERMIT
PLANNING AND ENVIRONMENT ACT 1987
WYNDHAM PLANNING SCHEME

Permit No: WYP10168/17.08

Condition No: 5

Sheet: 2 of 33

Approved by: Benny Singh

WYNDHAM CITY BUILDING

Date: 14 March 2019

- 1.5 **'Building Envelope Profiles'** means the profile section plans relevant to the Building Envelope. The applicable building envelope profile sections are marked on the Building Envelope Plan.
- 1.6 **'Building Permit'** means a building permit issued under the Building Act.
- 1.7 **'Building Regulations'** means the Building Regulations 2006 or any subsequent regulations made pursuant to the Building Act which regulate the siting of a Building.
- 1.8 **'Dwelling'** means a building and any associated outbuildings (including garages and carports) used for the purposes of a single domestic residence.
- 1.9 **'Finished Surface Level'** means the finished surface level of the ground at the time of registration of the Plan of Subdivision.
- 1.10 **'Front Street'** means the street or road which forms the frontage to the lot concerned. Where there is more than one road which adjoins a lot or where it may otherwise be unclear, the Front Street is identified by the location of the vehicular crossover to the lot on the building envelope plan.
- 1.11 **'Garage'** means a domestic garage or a domestic carport constructed primarily for the purpose of storage of motor vehicles, trailers, caravans, campervans, boats and the like.
- 1.12 **'Habitable Room'** has the same meaning as in the Building Code of Australia.
- 1.13 **'MCP'** means this Memorandum of Common Provisions.
- 1.14 **'Plan of Subdivision'** means the relevant plan of subdivision for a particular allotment which incorporates this MCP.
- 1.15 **'Riverwalk Residential Design Controls'** means the Riverwalk Design Standards (and associated referenced documents) prepared by Development Victoria, as amended from time to time.
- 1.16 **'Setback'** means the shortest horizontal distance from a particular boundary or building to another boundary or building (excepting matters specifically referred to in this MCP).
- 1.17 **'Side Street'** means a street or road which abuts an allotment other than a Front Street.
- 1.18 **'Development Victoria'** means Development Victoria created pursuant to the Development Victoria Act 2003.

2. SITING AND DESIGN

2.1 Exemption from the need for the Consent and Report of the relevant Council.

The restriction in the Plan of Subdivision which incorporates this MCP exempts a design from requiring the consent and report of the relevant council with regard to a design which does not comply with the Building Regulations in respect of the following:

- 2.1.1 Minimum Street Setback (regulation 409);
- 2.1.2 Site Coverage (regulation 411);
- 2.1.3 Side Setback and rear Setback (regulation 414);
- 2.1.4 Walls on boundaries (regulation 415);
- 2.1.5 Daylight to existing Habitable Room windows (regulation 416);
- 2.1.6 Daylight to Habitable Room windows (regulation 420).

Memorandum of common provisions
Section 91A Transfer of Land Act 1958

PLAN / DOCUMENT AS REQUIRED UNDER CONDITION OF PERMIT
PLANNING AND ENVIRONMENT ACT 1987
WYNDHAM PLANNING SCHEME

Permit No: WYP10168/17.08

Condition No: 5

Sheet: 3 of 53

Approved by: Benny Singh

WYNDHAM CITY COUNCIL

Date: 14 March 2019

2.2 Approved Building Envelopes

A Building (other than a boundary fence or other specific tolerable encroachments pursuant to this MCP) must be sited within the Approved Building Envelope and Building Envelope Profiles. The siting of a building within the Approved Building Envelope is subject to any further restriction or modification imposed by this MCP or any other applicable control.

2.3 Building Envelope Profiles

The heights specified with the Building Envelope Profiles are to be taken from the relevant spot "Finished Surface Level" of the site. Maximum building heights between specified points on a Setback profile lie on a straight line drawn between two specified points within a profile. The delineation of the profiles is demonstrated on the Building Envelopes plans. The Building Envelope Profiles are defined only by means of the side Setbacks of the Building Envelope. Rear Setback are to accord with the specifications outlined in Table 414 of the Building Regulations.

2.4 Minimum Front and Side Street Setbacks

No Dwelling shall be Setback from the Front Street less than 3.0 metres and Side Street less than 2.0 metres, unless otherwise reflected on the Approved Building Envelope.

2.5 Encroachments into Front Street Setback

The following may impose beyond the Approved Building Envelope and Building Envelope Profiles and encroach in to a Front Setback by not more than 1.50 metres:

- (a) An eave (including fascias & gutter);
- (b) A porch;
- (c) A verandah;
- (d) A portico;
- (e) A pergola;
- (f) A masonry chimney;
- (g) A sunblind;
- (h) A flue or pipe; and
- (i) Decks, steps or landings less than 800 millimetres in height.

None of the above structures may be greater than 3.6 metres in height.

2.6 Encroachments into side and rear Setback

2.6.1 The following may impose beyond the Approved Building Envelope and Building Envelope Profiles and encroach in to a side or rear Setback by not more than 500 millimetres:

- (a) A porch or verandah;
- (b) A masonry chimney;
- (c) A sunblind;
- (d) A screen which prevents direct overlooking;

Memorandum of common provisions
Section 91A Transfer of Land Act 1958

**PLAN / DOCUMENT AS REQUIRED UNDER CONDITION OF PERMIT
PLANNING AND ENVIRONMENT ACT 1987
WYNDHAM PLANNING SCHEME**

Permit No: WYP10168/17.08

Condition No: 5

Sheet: 4 of 53

Approved by: Benny Singh

WYNDHAM CITY COUNCIL

Date: 14 March 2019

- (e) A flue or pipe;
- (f) A domestic fuel tank;
- (g) Heating and cooling equipment or other services; and
- (h) An eave (including fascias and gutter).

2.6.2 The following may impose beyond the Approved Building Envelope and Building Envelope Profiles and encroach in to a side or rear Setback:

- (a) A landing with an area of not more than 2.0 metres and which is less than 800 millimetres in height above "Finished Surface Level";
- (b) An unroofed stairway or ramp;
- (c) A pergola;
- (d) Shade sails; and
- (e) A domestic watertank.

2.7 Site Coverage

The site coverage of:

- front loaded buildings must not occupy more than 70% of an allotment; and
- side or rear loaded buildings must not occupy more than 75% of an allotment.

2.8 Walls on boundaries

Where a Building Envelope allows construction of a building on the boundary of the lot, a wall or carport on the boundary may have a maximum length equivalent to the length of the envelope abutting the boundary (subject to the Building providing an adequate Garage Setback as required by Clause 2.12). The height of a wall or carport must not exceed a maximum height of 3.6 metres. The average height of a wall or carport may be a maximum of 3.6 metres.

2.9 Daylight to Habitable Room windows

A Habitable Room window of a Building on an allotment must face an outdoor space or light court with a minimum dimension of 1.0 metre clear to the sky (not encroached by eaves, fascias and gutters), and not including land on an adjoining allotment.

2.10 Daylight to existing Habitable Room windows

Only where a Building Envelope allows construction on or within 150 millimetres of the boundary may a Building (including eaves, fascias and gutter) be constructed on or within 150 millimetres of the boundary. In this instance only, Buildings do not have to provide a Setback to accommodate a Habitable Room window in an existing Dwelling.

Memorandum of common provisions
Section 91A Transfer of Land Act 1958

**PLAN / DOCUMENT AS REQUIRED UNDER CONDITION OF PERMIT
PLANNING AND ENVIRONMENT ACT 1987
WYNDHAM PLANNING SCHEME**

Permit No: WYP10168/17.08

Condition No: 5

Sheet: 5 of 53

Approved by: Benny Singh

WYNDHAM CITY COUNCIL

Date: 14 March 2019

2.11 One Dwelling on a lot

With the exception of those lots identified with a * and ♦ and marked as “Dual Occupancy Site” or “Medium Density Site” on the “Building Envelopes Plan”, only one Dwelling may be erected on a lot within the Plan of Subdivision.

2.12 Minimum Garage Setbacks

A Garage on a lot, must be setback not less than 5.5 metres from the front boundary of the lot measured from the centrepoint of the garage to the centrepoint of the crossover, unless otherwise stated below.

On a corner lot that provides for garage access to the side street, a double Garage must be setback at least 2 metres measured from the centrepoint of the garage to the centrepoint of the crossover and a single Garage must be setback at least 5.5 metres measured from the centrepoint of the garage to the centrepoint of the crossover.

2.13 Location of Crossovers

The locations of the crossovers are fixed and must not be altered unless explicit consent is granted by Development Victoria or proxy.

2.14 Compliance and Discretion

Development Victoria or Wyndham City Council may authorize in writing the siting of a Building which does not comply with the restriction created by the Plan of Subdivision which incorporates this MCP, provided that such siting complies with the requirements of the Building Regulations and / or is subject to the report and consent of the relevant reporting authority in terms of the Building Regulations. Approval pursuant to this clause shall only be provided in circumstances where Development Victoria or Wyndham City Council considers that the siting is desirable in terms of achieving a better planning outcome in terms of the Riverwalk Residential Design Controls that may otherwise be achieved and will not result in any significant detriment to abutting owners or occupiers.

2.15 Developer Fencing

Development Victoria will provide side fencing facing Geelong Road to lots 2401, 2444, 2445, 2470, 2472 & 2477.

3. APPROVAL OF HOUSE DESIGN

The explicit approval of the design and siting of a Dwelling to be built on any lot on the Plan of Subdivision PS 820862U must be granted by Development Victoria (or proxy) prior to making a formal application for a Building Permit. The design and siting of a Dwelling must be in accordance with and meet the requirements of the Riverwalk Residential Design Controls.

Memorandum of common provisions
Section 91A Transfer of Land Act 1958

**PLAN / DOCUMENT AS REQUIRED UNDER CONDITION OF PERMIT
PLANNING AND ENVIRONMENT ACT 1987
WYNDHAM PLANNING SCHEME**

Permit No: WYP10168/17.08

Condition No: 5

Sheet: 6 of 53

Approved by: Benny Singh

WYNDHAM CITY COUNCIL

Date: 14 March 2019

4. INTERPRETATION

In this MCP, unless the contrary intention appears:

- 4.1 The singular includes the plural and vice versa;
- 4.2 A reference to an individual or person includes a partnership, body corporate, government authority or agency and vice versa;
- 4.3 Words importing one gender include other genders;
- 4.4 Other grammatical forms of defined words or expressions have corresponding meanings;
- 4.5 A reference to a statute, code or other law includes regulations and other instruments made under it and includes consolidations, amendments, re-enactments or replacements of any of them;
- 4.6 A reference to the Riverwalk Residential Design Controls is reference to that document or subsequent or amended documents (whether they are named as such) that are prepared to guide and control the development of land within the Plan of Subdivision;
- 4.7 A reference to an authority, institution, association or body ('original entity') that has ceased to exist or been reconstituted, renamed or replaced or whose powers or functions have been transferred to another entity, is reference to the entity that most closely serves the purposes or objects of the original entity;
- 4.8 Headings and the provision of a table of contents are for convenience only and do not affect the interpretation of this MCP.

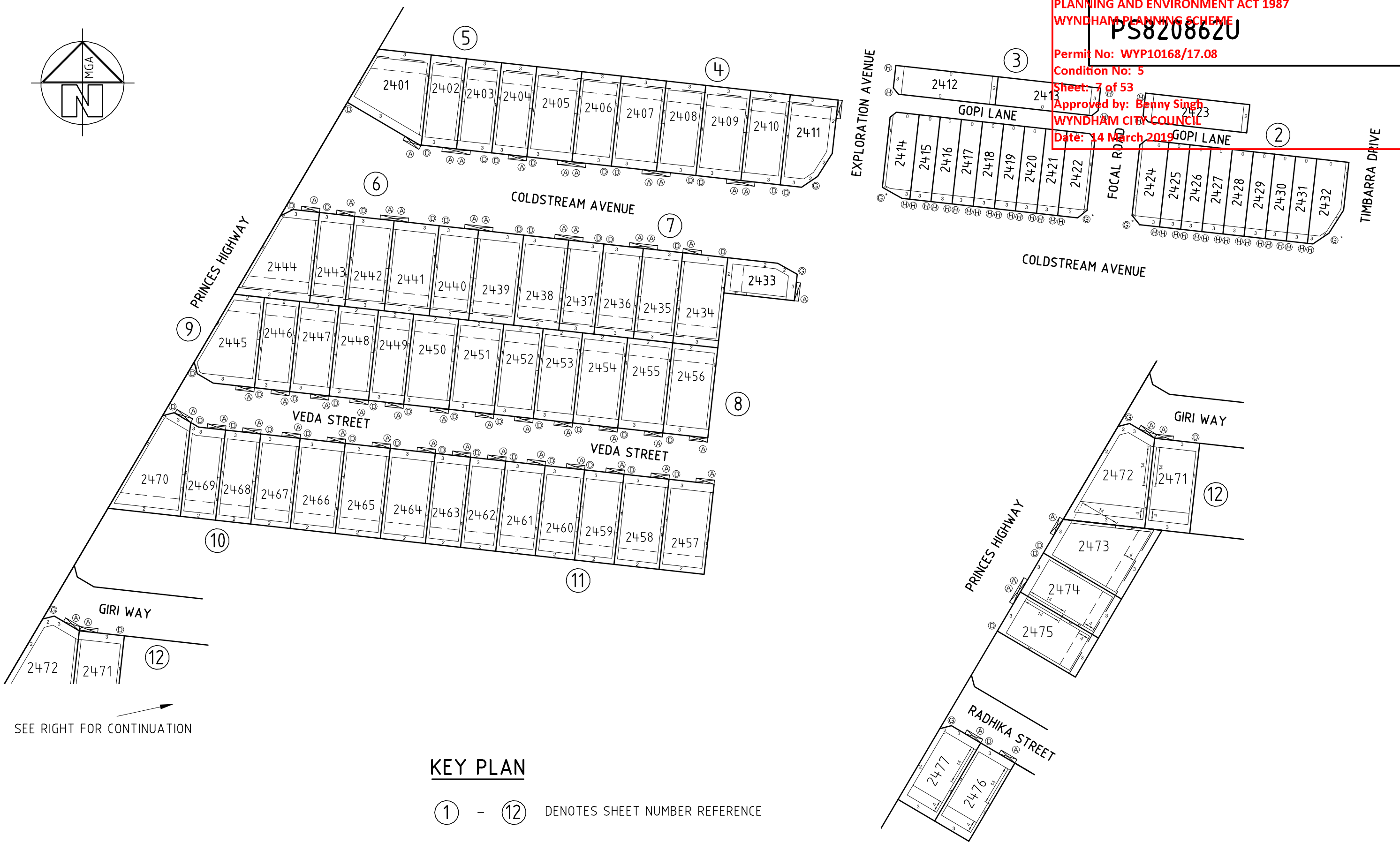
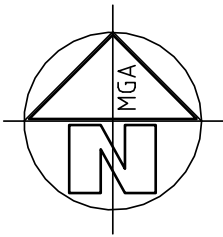

KEY PLAN

① - ⑫ DENOTES SHEET NUMBER REFERENCE

SEE RIGHT FOR CONTINUATION

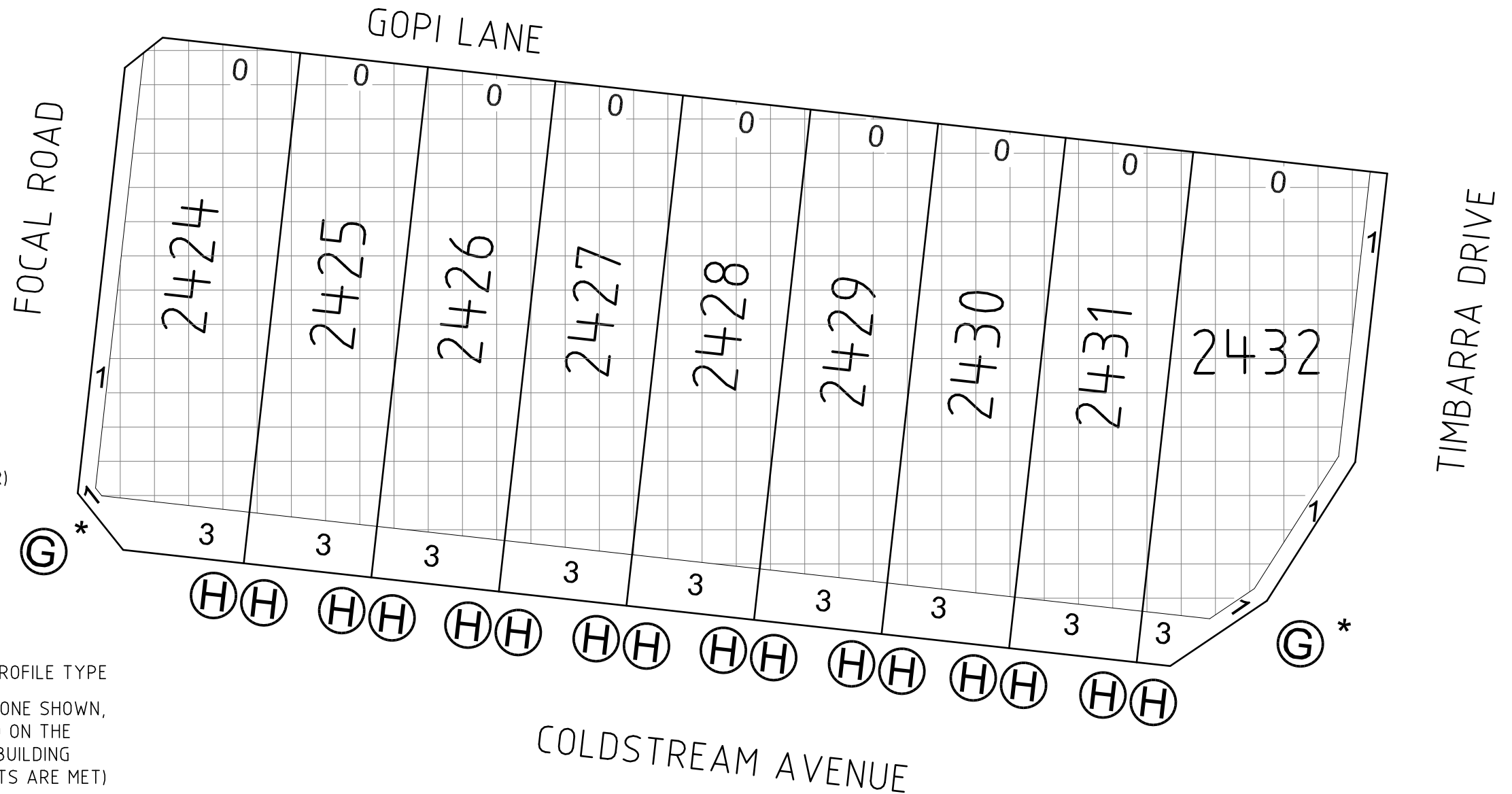
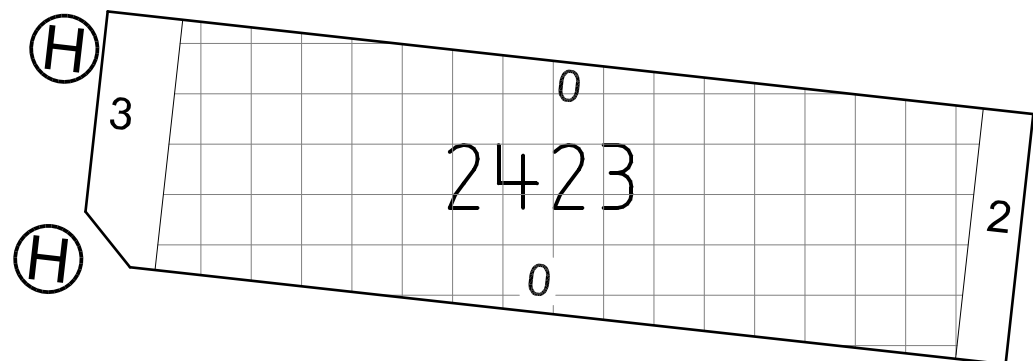
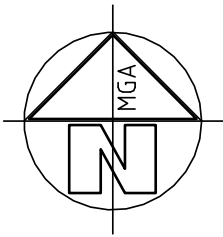

2401 LOT NUMBER

- (A)** BUILDING ENVELOPE BOUNDARY PROFILE TYPE
- 2** SETBACK MINIMUM REQUIRED (IF NONE SHOWN, A BUILDING CAN BE CONSTRUCTED ON THE BOUNDARY PROVIDED THAT THE BUILDING HEIGHT AND LENGTH REQUIREMENTS ARE MET)

 DESIGNATED VEHICLE CROSSOVER TO LOT (NO OTHER VEHICULAR ACCESS POINT IS PERMITTED TO A LOT, EXCEPT WITH THE APPROVAL OF DEVELOPMENT VICTORIA AND WYNDHAM CITY COUNCIL)

PLAN / DOCUMENT AS REQUIRED UNDER CONDITION OF PERMIT
 PLANNING AND ENVIRONMENT ACT 1987
 WYNDHAM PLANNING SCHEME
PS820862U
 Permit No: WYP10168/17.08
 Condition No: 5
 Sheet: 9 of 53
 Approved by: Benny Singh
 WYNDHAM CITY COUNCIL
 Date: 14 March 2019

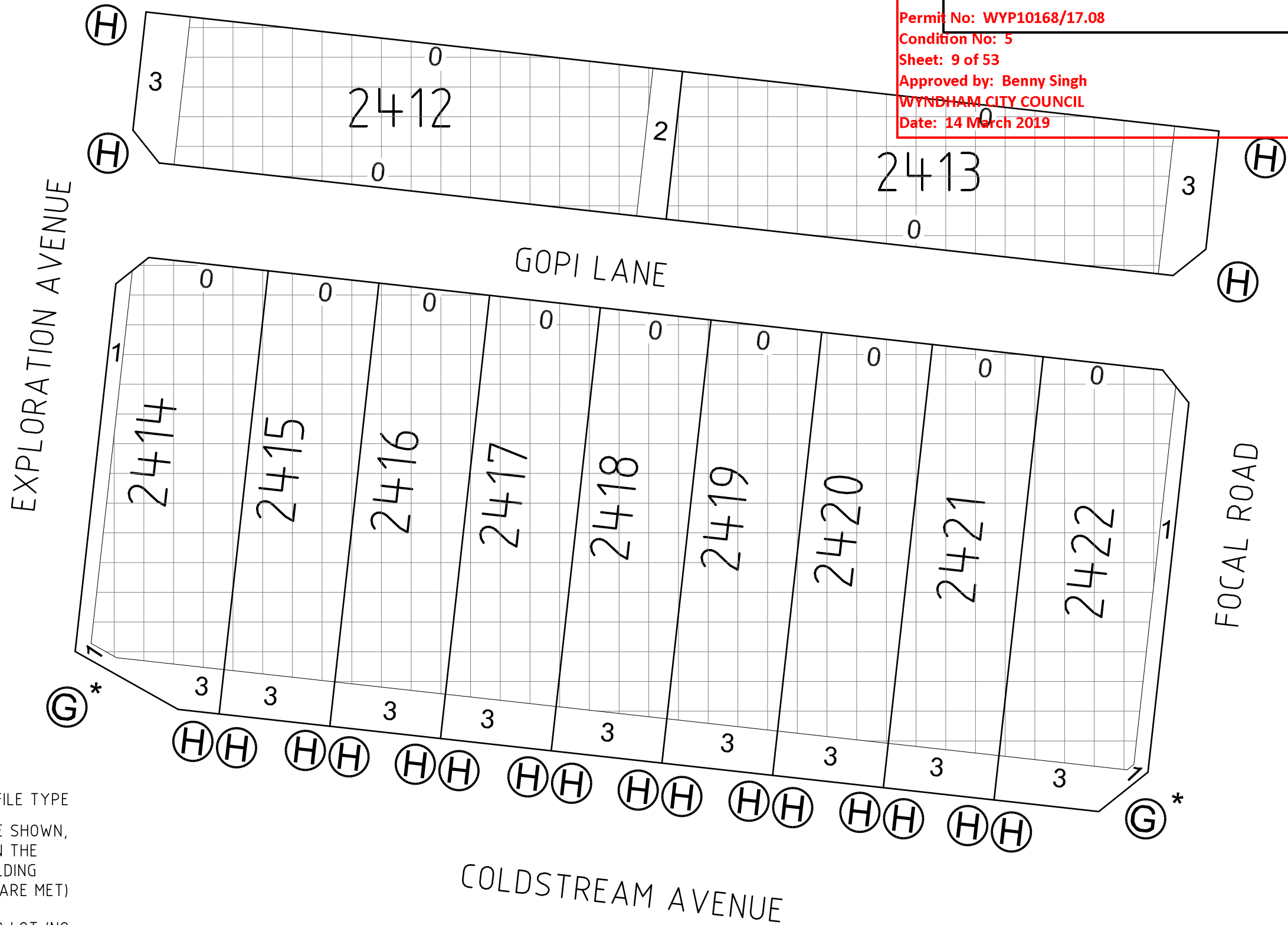
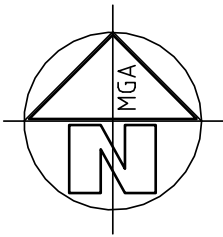

BUILDING ENVELOPE (GROUND FLOOR)
 BUILDING ENVELOPE (FIRST FLOOR)

2401 LOT NUMBER

(A) BUILDING ENVELOPE BOUNDARY PROFILE TYPE
2 SETBACK MINIMUM REQUIRED (IF NONE SHOWN, A BUILDING CAN BE CONSTRUCTED ON THE BOUNDARY PROVIDED THAT THE BUILDING HEIGHT AND LENGTH REQUIREMENTS ARE MET)

DESIGNATED VEHICLE CROSSOVER TO LOT (NO OTHER VEHICULAR ACCESS POINT IS PERMITTED TO A LOT, EXCEPT WITH THE APPROVAL OF DEVELOPMENT VICTORIA AND WYNDHAM CITY COUNCIL)

CRA SURVEY PTY LTD
 LAND SURVEYORS TOWN PLANNERS
 DEVELOPMENT CONSULTANTS
 7A/346 Belmore Road office@crsurvey.com.au
 Balwyn Vic 3103 Tel: 03 9890 0933

REF: 3936BE24

VERSION: 2 (30.11.18)

SCALE
 1 : 300

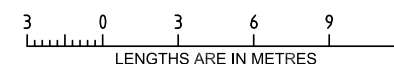





ORIGINAL SHEET
 SIZE: A3

SHEET 3 OF 13

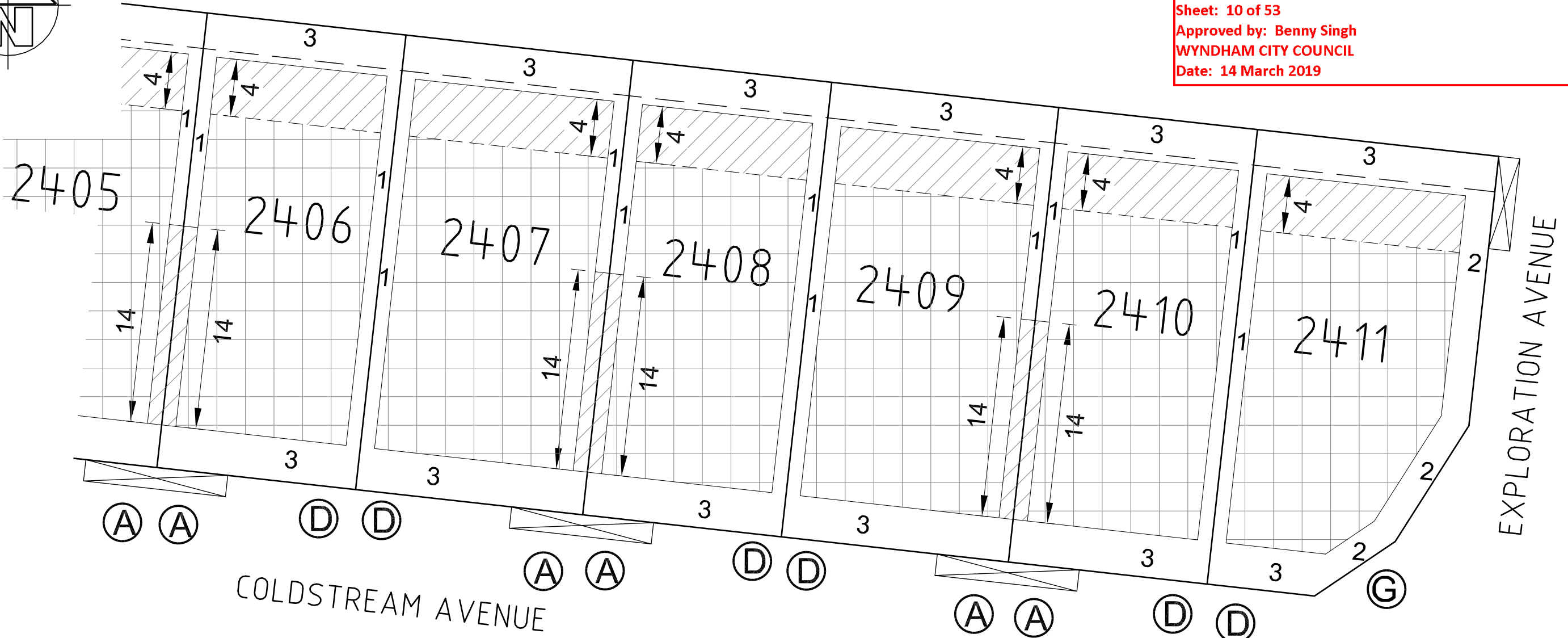
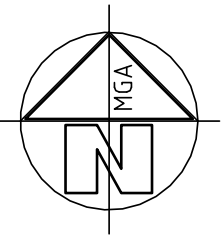

RIVERWALK RELEASE 24
 BUILDING ENVELOPE PLANS

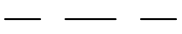

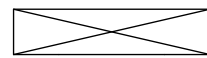
-  BUILDING ENVELOPE (GROUND FLOOR)
-  BUILDING ENVELOPE (FIRST FLOOR)
-  2.5 METRE WIDE EASEMENT
- 2401 LOT NUMBER
-  BUILDING ENVELOPE BOUNDARY PROFILE TYPE
- 2 SETBACK MINIMUM REQUIRED (IF NONE SHOWN, A BUILDING CAN BE CONSTRUCTED ON THE BOUNDARY PROVIDED THAT THE BUILDING HEIGHT AND LENGTH REQUIREMENTS ARE MET)
-  DESIGNATED VEHICLE CROSSOVER TO LOT (NO OTHER VEHICULAR ACCESS POINT IS PERMITTED TO A LOT, EXCEPT WITH THE APPROVAL OF DEVELOPMENT VICTORIA AND WYNDHAM CITY COUNCIL)

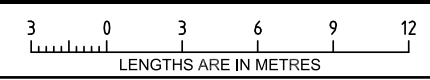

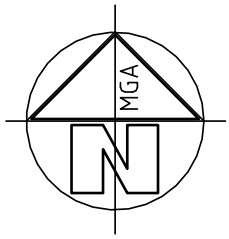

PRINCES HIGHWAY

(D)

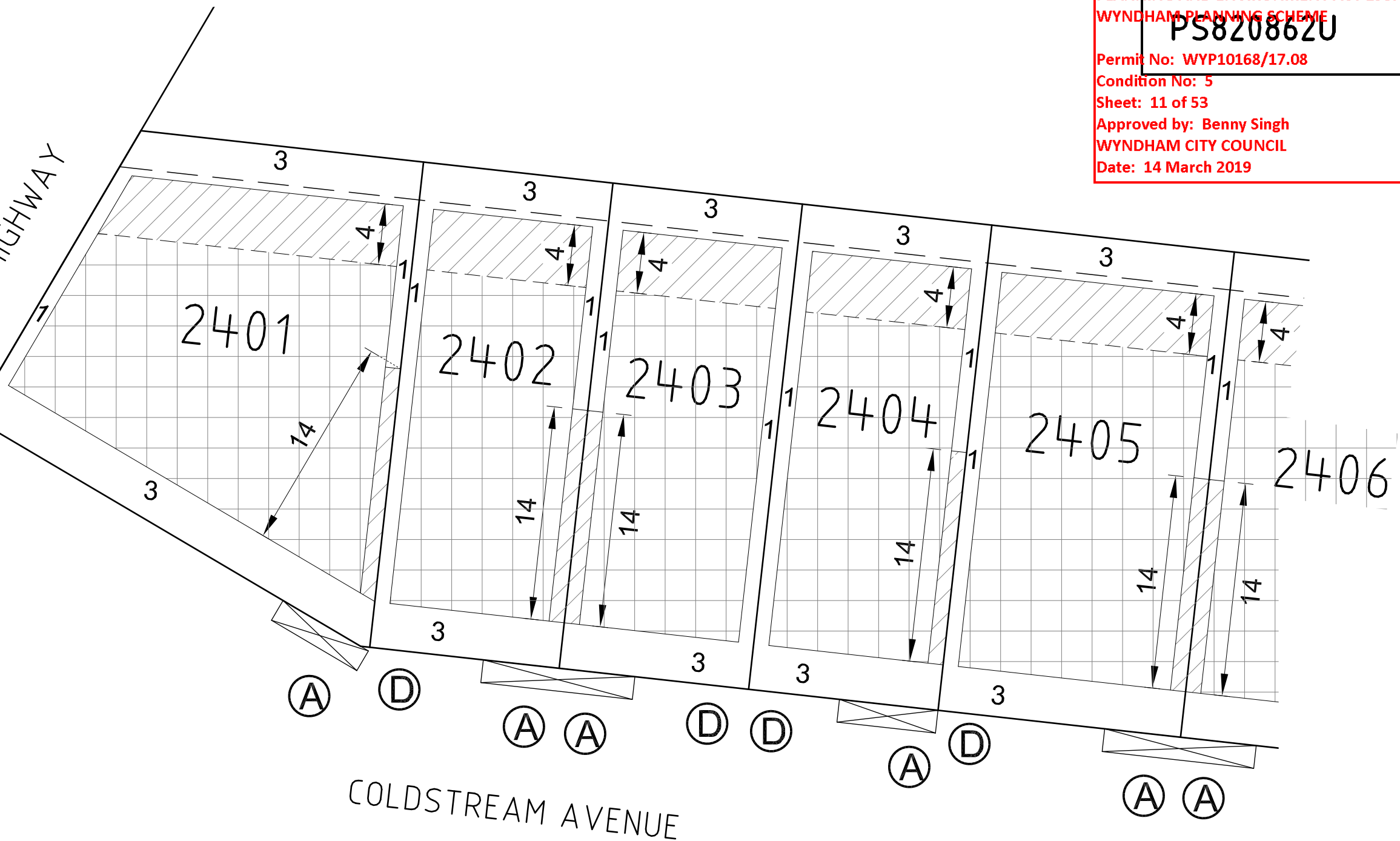

COLDSTREAM AVENUE

(A)

(D)

(A) (A)

(D) (D)

(A) (D)

(A) (A)

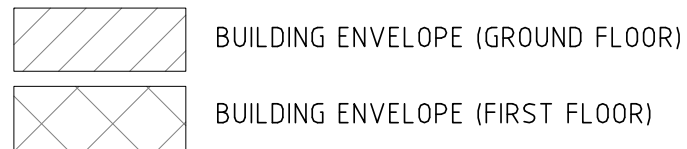

--- 2.5 METRE WIDE EASEMENT

2401 LOT NUMBER

(A)

BUILDING ENVELOPE BOUNDARY PROFILE TYPE

2

SETBACK MINIMUM REQUIRED (IF NONE SHOWN, A BUILDING CAN BE CONSTRUCTED ON THE BOUNDARY PROVIDED THAT THE BUILDING HEIGHT AND LENGTH REQUIREMENTS ARE MET)

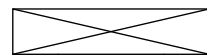

DESIGNATED VEHICLE CROSSOVER TO LOT (NO OTHER VEHICULAR ACCESS POINT IS PERMITTED TO A LOT, EXCEPT WITH THE APPROVAL OF DEVELOPMENT VICTORIA AND WYNDHAM CITY COUNCIL)

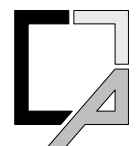

CRA SURVEY PTY LTD
 LAND SURVEYORS TOWN PLANNERS
 DEVELOPMENT CONSULTANTS
 7A/346 Belmore Road office@crasurvey.com.au
 Balwyn Vic 3103 Tel: 03 9890 0933

REF: 3936BE24

VERSION: 2 (30.11.18)

SCALE
 1 : 300

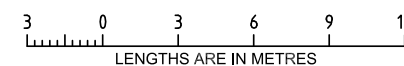



ORIGINAL SHEET
 SIZE: A3

SHEET 5 OF 13

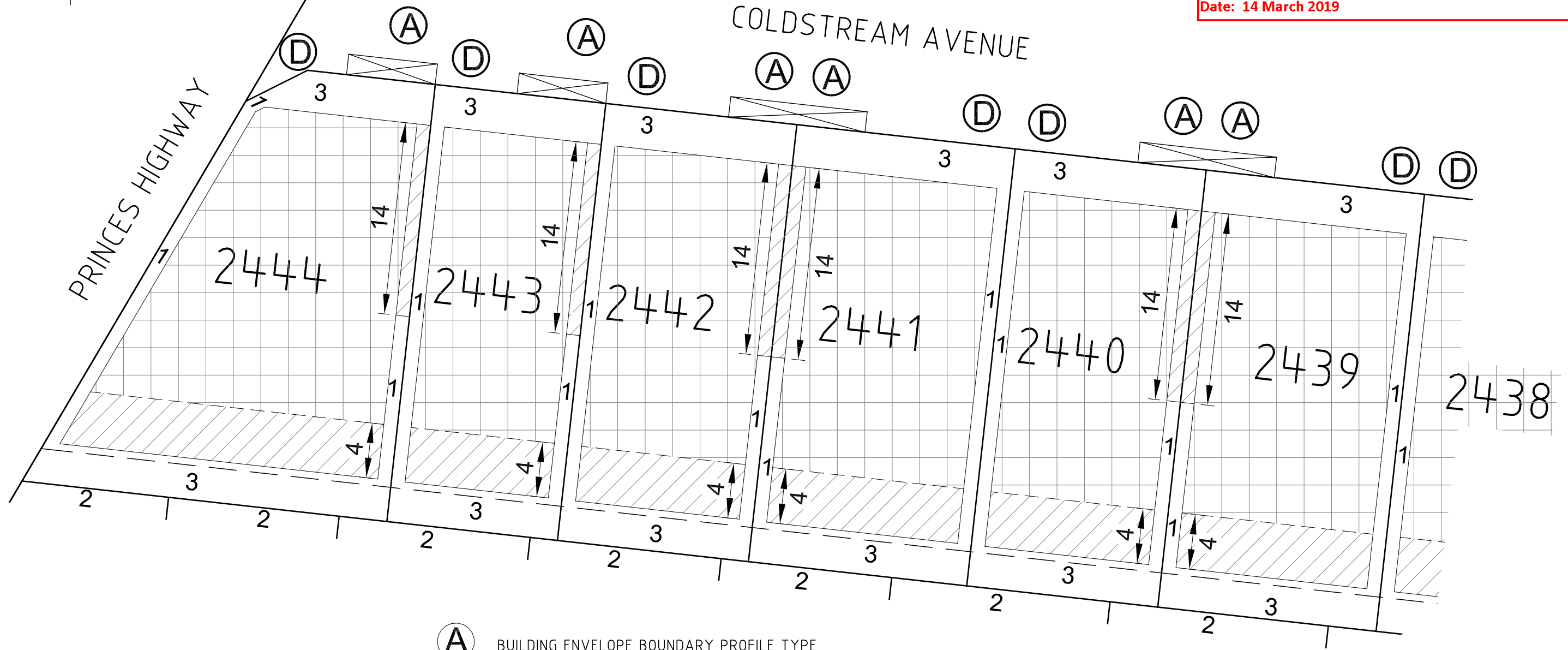
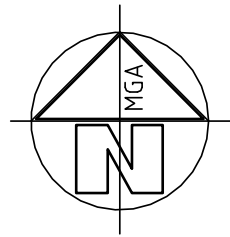

**RIVERWALK RELEASE 24
 BUILDING ENVELOPE PLANS**

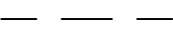
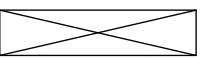

-  BUILDING ENVELOPE (GROUND FLOOR)
-  BUILDING ENVELOPE (FIRST FLOOR)
-  2.5 METRE WIDE EASEMENT
-  DESIGNATED VEHICLE CROSSOVER TO LOT (NO OTHER VEHICULAR ACCESS POINT IS PERMITTED TO A LOT, EXCEPT WITH THE APPROVAL OF DEVELOPMENT VICTORIA AND WYNDHAM CITY COUNCIL)
- (A)** BUILDING ENVELOPE BOUNDARY PROFILE TYPE
- 2** SETBACK MINIMUM REQUIRED (IF NONE SHOWN, A BUILDING CAN BE CONSTRUCTED ON THE BOUNDARY PROVIDED THAT THE BUILDING HEIGHT AND LENGTH REQUIREMENTS ARE MET)
- 2401** LOT NUMBER

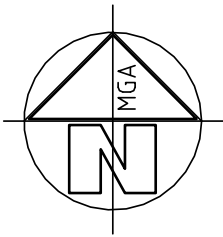

COLDSTREAM AVENUE

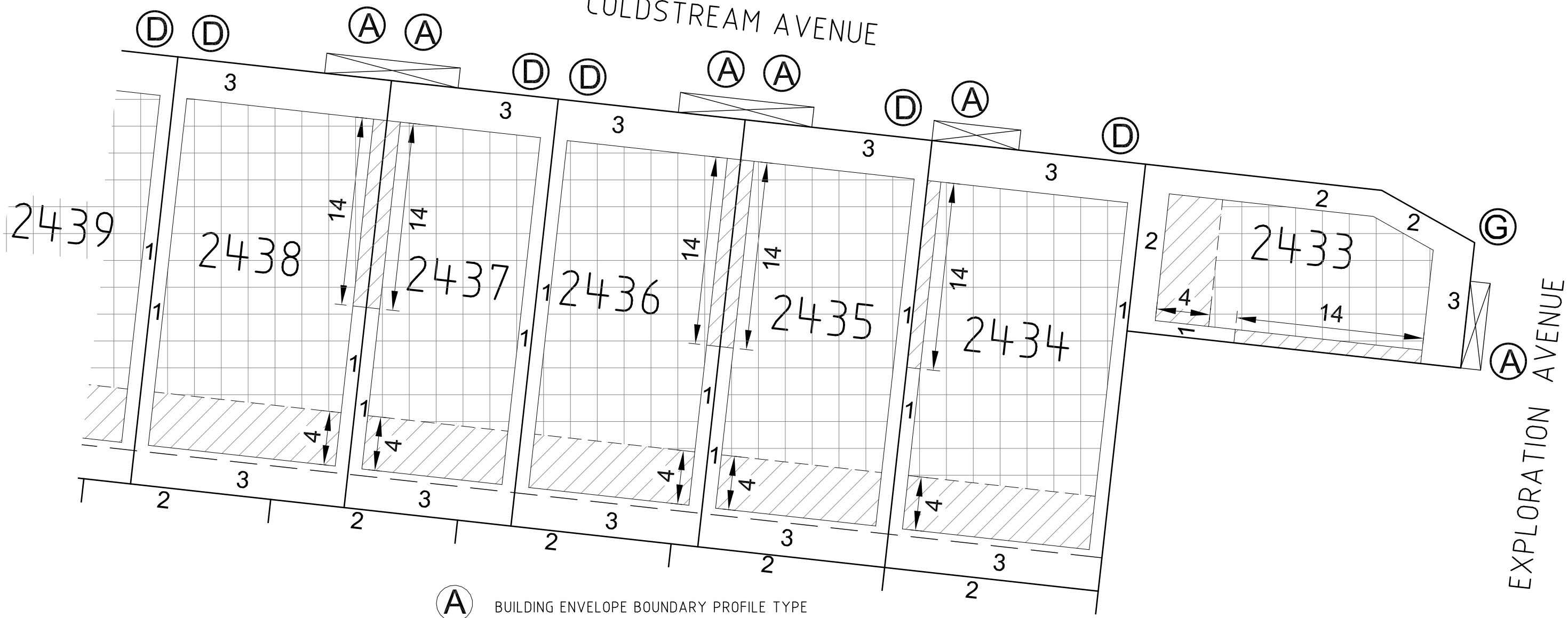

EXPLORATION AVENUE



--- 2.5 METRE WIDE EASEMENT



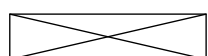

2401 LOT NUMBER

(A) BUILDING ENVELOPE BOUNDARY PROFILE TYPE

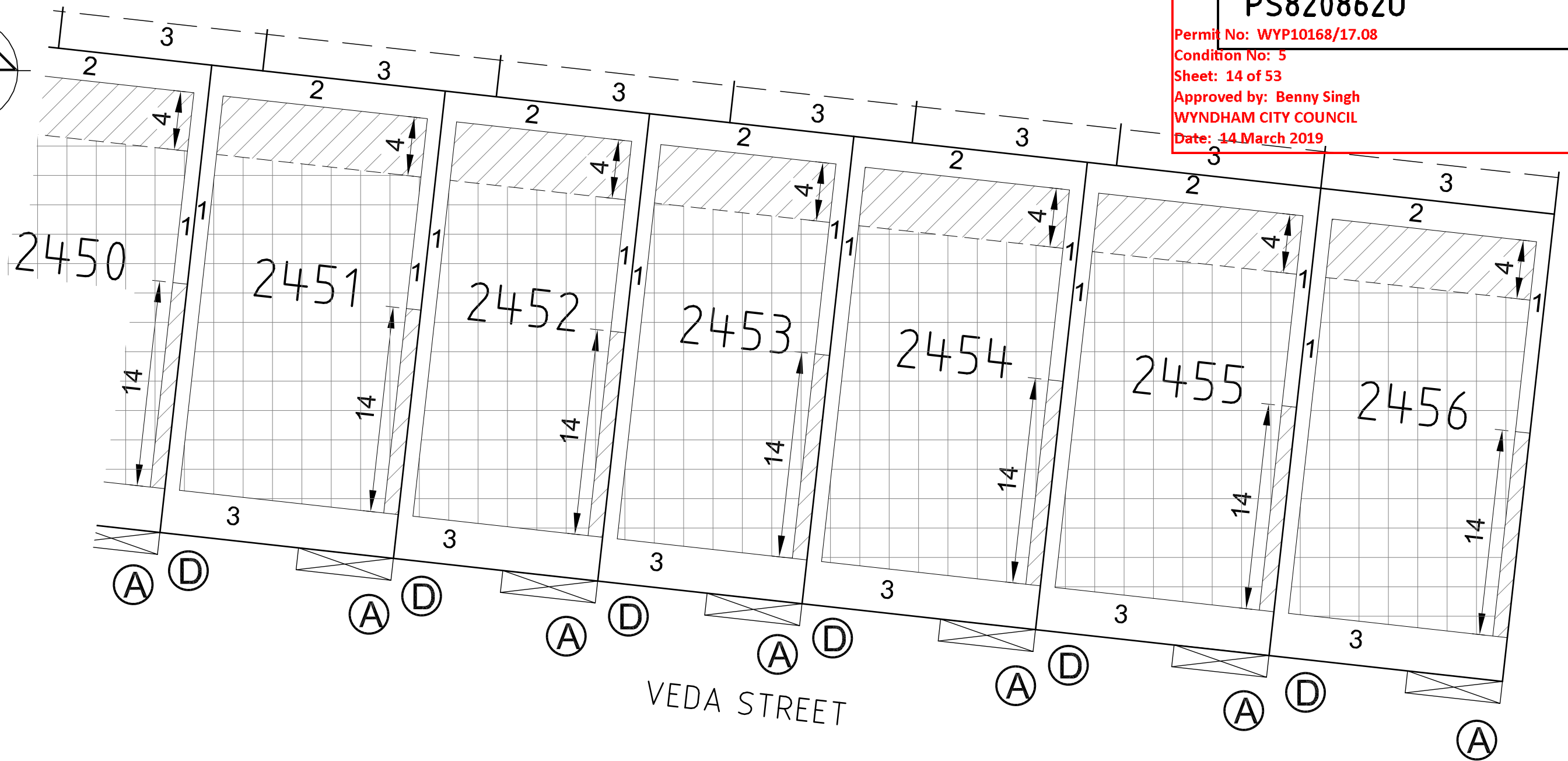
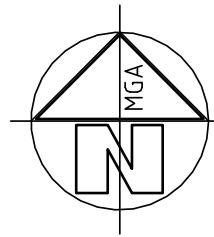
2 SETBACK MINIMUM REQUIRED (IF NONE SHOWN, A BUILDING CAN BE CONSTRUCTED ON THE BOUNDARY PROVIDED THAT THE BUILDING HEIGHT AND LENGTH REQUIREMENTS ARE MET)

 DESIGNATED VEHICLE CROSSOVER TO LOT (NO OTHER VEHICULAR ACCESS POINT IS PERMITTED TO A LOT, EXCEPT WITH THE APPROVAL OF DEVELOPMENT VICTORIA AND WYNDHAM CITY COUNCIL)

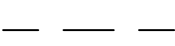
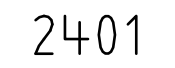

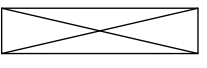
-  BUILDING ENVELOPE (GROUND FLOOR)
-  BUILDING ENVELOPE (FIRST FLOOR)
-  2.5 METRE WIDE EASEMENT
-  LOT NUMBER
-  BUILDING ENVELOPE BOUNDARY PROFILE TYPE
-  SETBACK MINIMUM REQUIRED (IF NONE SHOWN, A BUILDING CAN BE CONSTRUCTED ON THE BOUNDARY PROVIDED THAT THE BUILDING HEIGHT AND LENGTH REQUIREMENTS ARE MET)
-  DESIGNATED VEHICLE CROSSOVER TO LOT (NO OTHER VEHICULAR ACCESS POINT IS PERMITTED TO A LOT, EXCEPT WITH THE APPROVAL OF DEVELOPMENT VICTORIA AND WYNDHAM CITY COUNCIL)

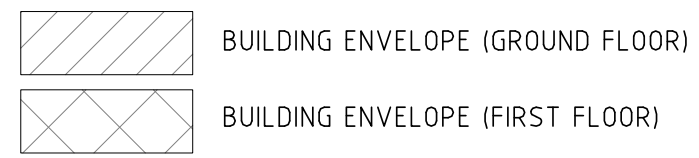
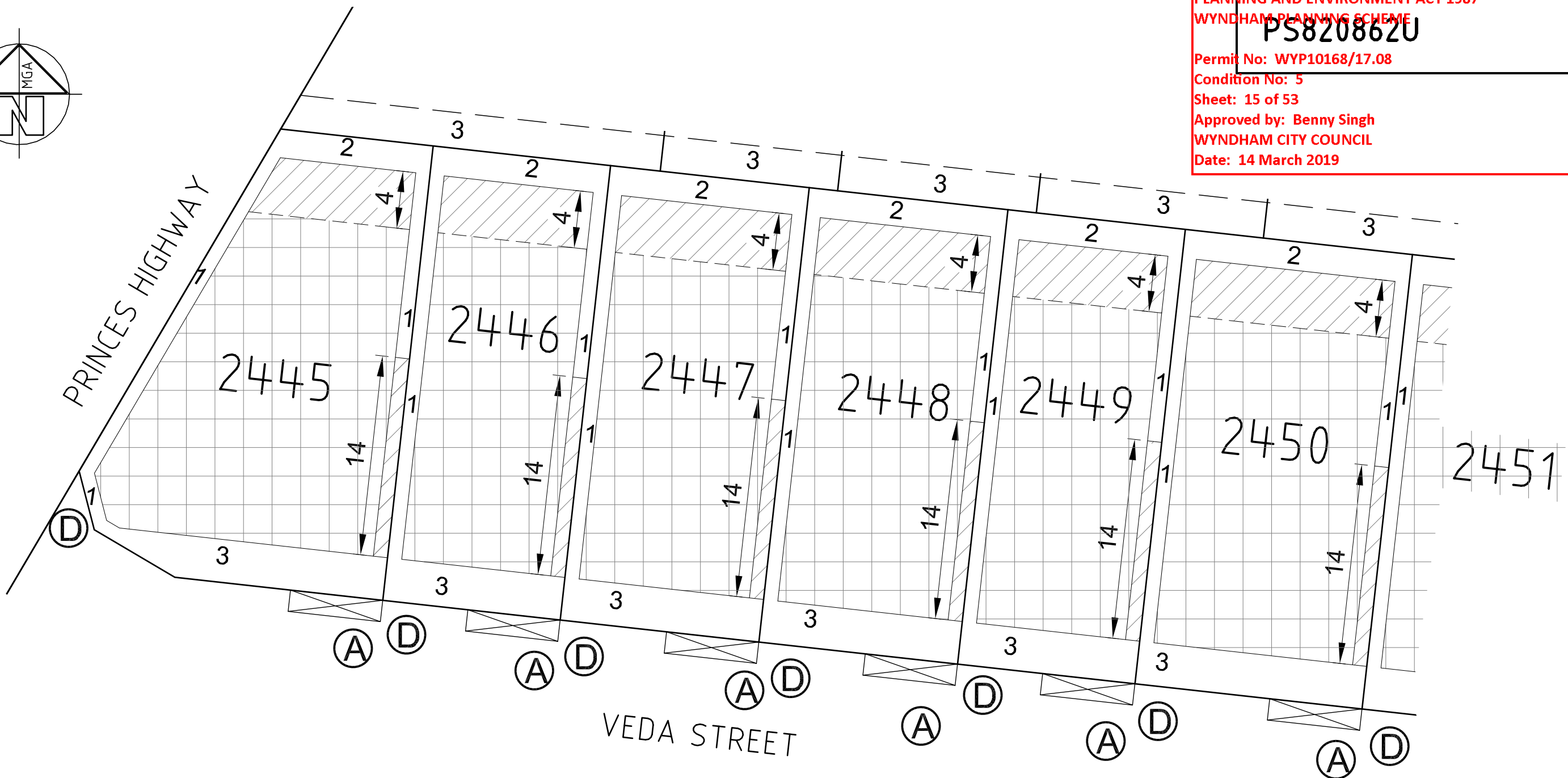
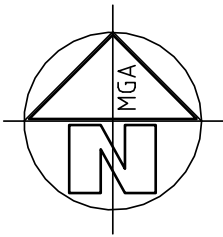

--- 2.5 METRE WIDE EASEMENT

2401 LOT NUMBER

(A) BUILDING ENVELOPE BOUNDARY PROFILE TYPE
2 SETBACK MINIMUM REQUIRED (IF NONE SHOWN, A BUILDING CAN BE CONSTRUCTED ON THE BOUNDARY PROVIDED THAT THE BUILDING HEIGHT AND LENGTH REQUIREMENTS ARE MET)

DESIGNATED VEHICLE CROSSOVER TO LOT (NO OTHER VEHICULAR ACCESS POINT IS PERMITTED TO A LOT, EXCEPT WITH THE APPROVAL OF DEVELOPMENT VICTORIA AND WYNDHAM CITY COUNCIL)

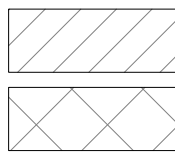
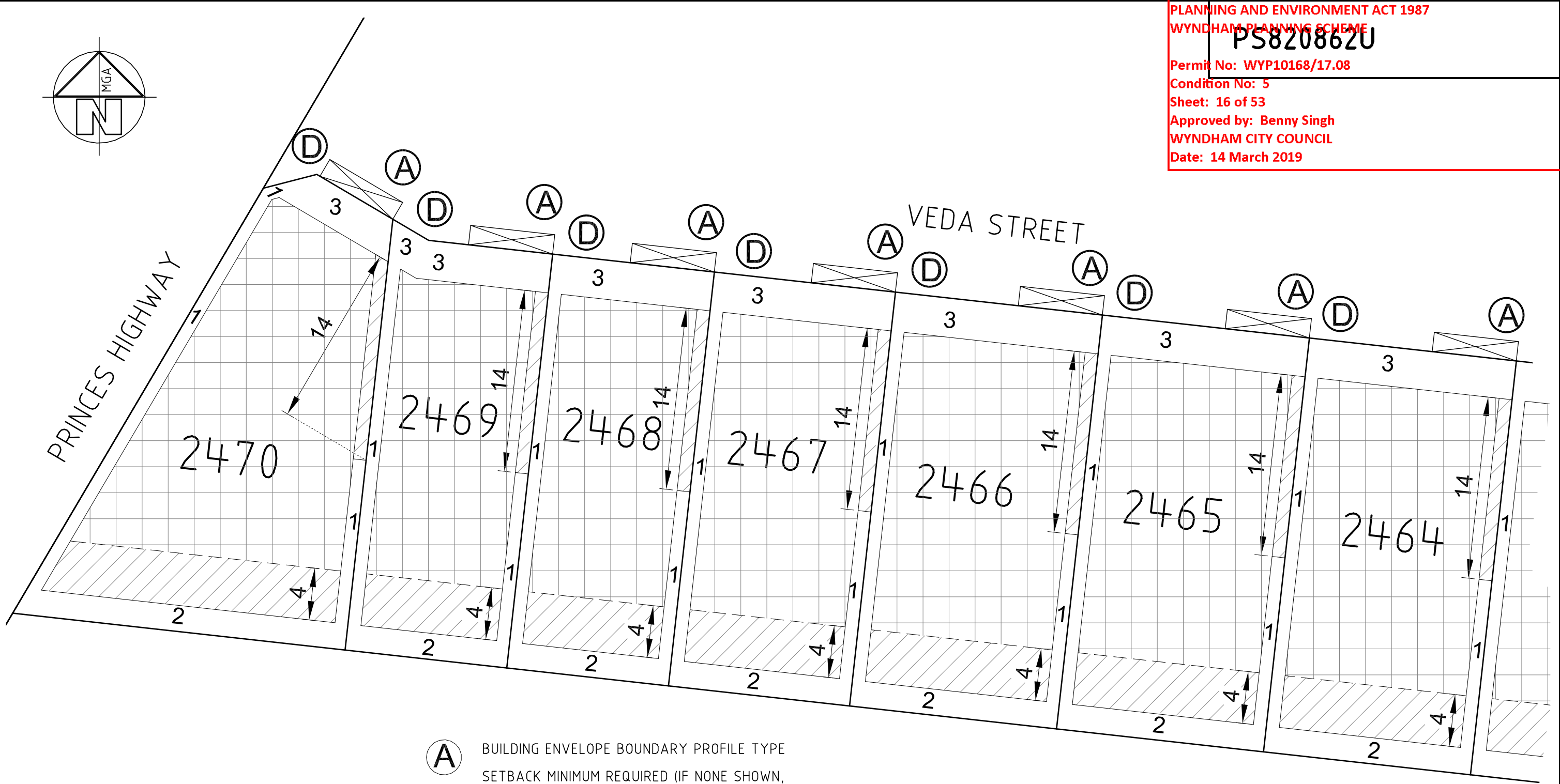

BUILDING ENVELOPE (GROUND FLOOR)
 BUILDING ENVELOPE (FIRST FLOOR)

2401 LOT NUMBER



A BUILDING ENVELOPE BOUNDARY PROFILE TYPE
 SETBACK MINIMUM REQUIRED (IF NONE SHOWN, A BUILDING CAN BE CONSTRUCTED ON THE BOUNDARY PROVIDED THAT THE BUILDING HEIGHT AND LENGTH REQUIREMENTS ARE MET)



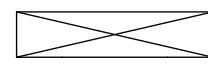

2 DESIGNATED VEHICLE CROSSOVER TO LOT (NO OTHER VEHICULAR ACCESS POINT IS PERMITTED TO A LOT, EXCEPT WITH THE APPROVAL OF DEVELOPMENT VICTORIA AND WYNDHAM CITY COUNCIL)

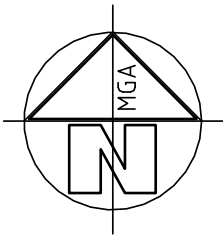

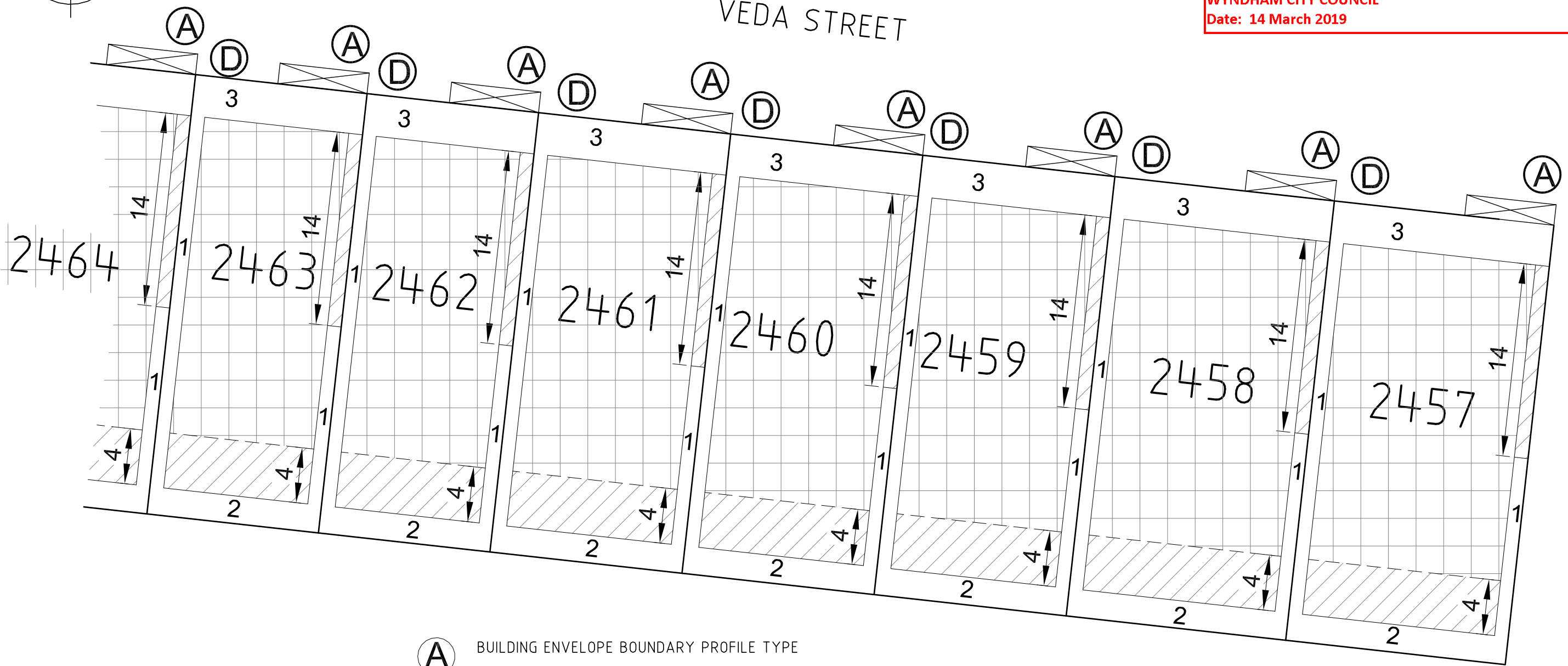

VEDA STREET

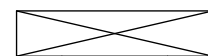

-  BUILDING ENVELOPE (GROUND FLOOR)
 -  BUILDING ENVELOPE (FIRST FLOOR)
 -  DESIGNATED VEHICLE CROSSOVER TO LOT (NO OTHER VEHICULAR ACCESS POINT IS PERMITTED TO A LOT, EXCEPT WITH THE APPROVAL OF DEVELOPMENT VICTORIA AND WYNDHAM CITY COUNCIL)
 - (A)** BUILDING ENVELOPE BOUNDARY PROFILE TYPE
 - (D)** SETBACK MINIMUM REQUIRED (IF NONE SHOWN, A BUILDING CAN BE CONSTRUCTED ON THE BOUNDARY PROVIDED THAT THE BUILDING HEIGHT AND LENGTH REQUIREMENTS ARE MET)
 - 2** DESIGNATED VEHICLE CROSSOVER TO LOT (NO OTHER VEHICULAR ACCESS POINT IS PERMITTED TO A LOT, EXCEPT WITH THE APPROVAL OF DEVELOPMENT VICTORIA AND WYNDHAM CITY COUNCIL)
- 2401 LOT NUMBER

PLAN / DOCUMENT AS REQUIRED UNDER CONDITION OF PERMIT
 PLANNING AND ENVIRONMENT ACT 1987
 WYNDHAM PLANNING SCHEME
PS820862U
 Permit No: WYP10168/17.08
 Condition No: 5
 Sheet 18 of 53
 Approved by: Benny Singh
 WYNDHAM CITY COUNCIL
 Date: 14 March 2019

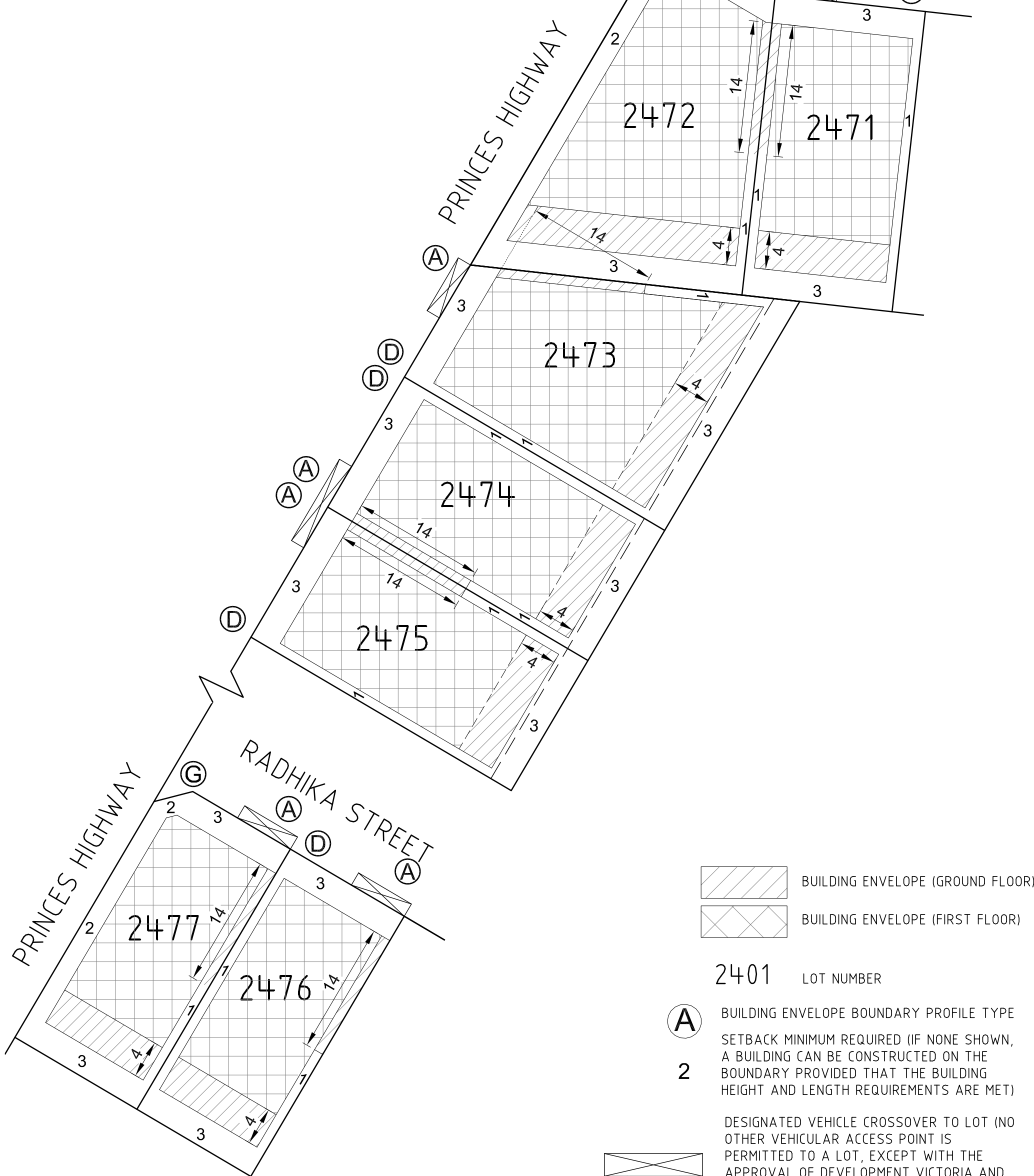
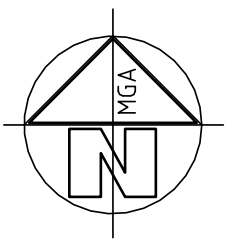

BUILDING ENVELOPE (GROUND FLOOR)
 BUILDING ENVELOPE (FIRST FLOOR)

2401 LOT NUMBER

(A) BUILDING ENVELOPE BOUNDARY PROFILE TYPE
 SETBACK MINIMUM REQUIRED (IF NONE SHOWN, A BUILDING CAN BE CONSTRUCTED ON THE BOUNDARY PROVIDED THAT THE BUILDING HEIGHT AND LENGTH REQUIREMENTS ARE MET)
2

DESIGNATED VEHICLE CROSSOVER TO LOT (NO OTHER VEHICULAR ACCESS POINT IS PERMITTED TO A LOT, EXCEPT WITH THE APPROVAL OF DEVELOPMENT VICTORIA AND WYNDHAM CITY COUNCIL)

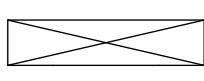

REF: 3936BE24 VERSION: 2 (30.11.18)

CRA SURVEY PTY LTD
 LAND SURVEYORS TOWN PLANNERS
 DEVELOPMENT CONSULTANTS
 7A/346 Belmore Road office@crsurvey.com.au
 Balwyn Vic 3103 Tel: 03 9890 0933

SCALE
 1 : 400

 LENGTHS ARE IN METRES

ORIGINAL SHEET
 SIZE: A3 SHEET 12 OF 13
**RIVERWALK RELEASE 24
 BUILDING ENVELOPE PLANS**

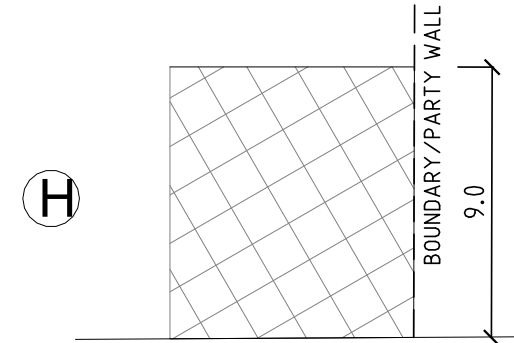
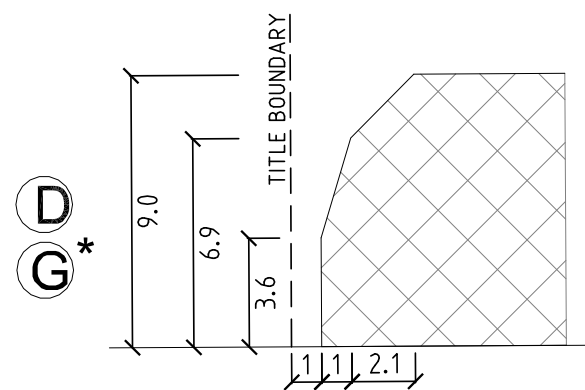
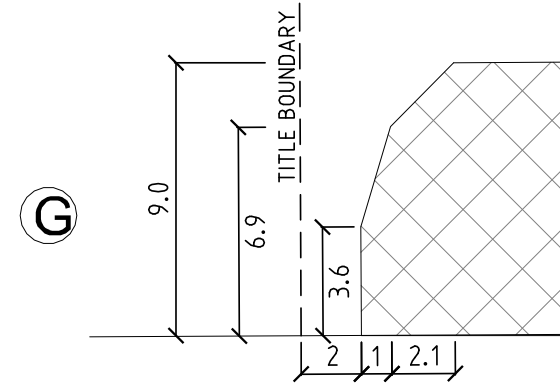
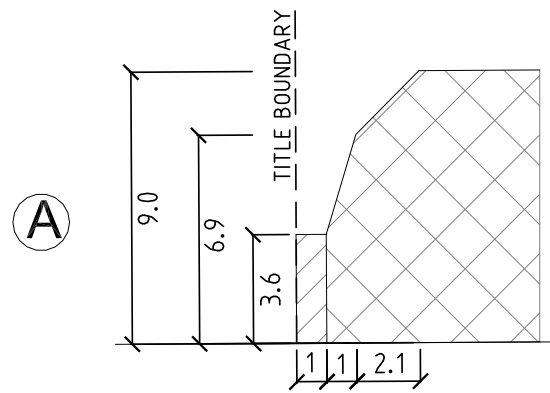

BUILDING ENVELOPE (GROUND FLOOR)



BUILDING ENVELOPE (FIRST FLOOR)

A

BUILDING ENVELOPE BOUNDARY PROFILE TYPE

2

SETBACK MINIMUM REQUIRED (IF NONE SHOWN, A BUILDING CAN BE CONSTRUCTED ON THE BOUNDARY PROVIDED THAT THE BUILDING HEIGHT AND LENGTH REQUIREMENTS ARE MET)

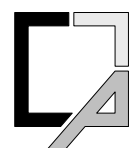

CRA SURVEY PTY LTD
LAND SURVEYORS TOWN PLANNERS
DEVELOPMENT CONSULTANTS

7A/346 Belmore Road office@crsurvey.com.au
Balwyn Vic 3103 Tel: 03 9890 0933

REF: 3936BE24

VERSION: 2 (30.11.18)

NOT TO SCALE

ORIGINAL SHEET
SIZE: A3

SHEET 13 OF 13



RIVERWALK RELEASE 24
BUILDING ENVELOPE PLANS